



## 3mm Infrared LED,T-1



### Features

- ◆ High reliability
- ◆ 2.54mm Lead spacing
- ◆ Pb Free
- ◆ High emission power, far from the launch distance, clear image
- ◆ Peak wavelength:  $\lambda=850\text{nm}$
- ◆ The batch consistency, 0.1V file voltage, 5nm wavelength grade
- ◆ The long service life, low driving voltage
- ◆ This product itself will remain within RoHS compliant version.

### Applications

- ◆ Applicable to security surveillance camera
- ◆ Free air transmission system
- ◆ Infrared remote control units with high power requirement
- ◆ Smoke detector
- ◆ Infrared applied system
- ◆ That is suitable for various sizes of touch screen



## Package Dimension

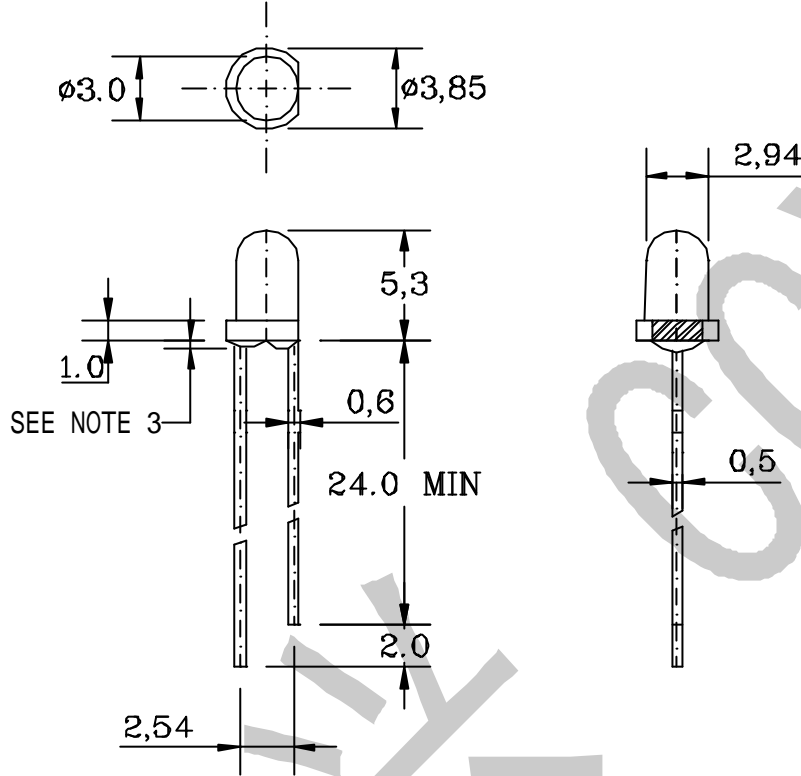

- Notes :
- 1、 All dimensions are in millimeters.
  - 2、 Tolerance is  $\pm 0.25$ mm unless otherwise noted.
  - 3、 Protruded resin under flange is 1.0mm max.

## Device Selection Guide

Chip Materials	Lens Color
GaAlAs	Water clear



## Absolute Maximum Ratings at Ta=25

Parameter	Symbol	MAX	Unit
Power Dissipation at(or below) 25 free air temperature	$P_d$	100	mW
Peak Forward Current (1/10 Duty Cycle,0.1ms Pulse Width)	$I_{FP}$	300	mA
Continuous Forward Current	$I_F$	50	mA
Reverse Voltage	$V_R$	5	V
Operating Temperature Range	$T_{opr}$	-40 to +85	
Storage Temperature Range	$T_{stg}$	-40 to +100	
Lead Soldering Temperature	$T_{sol}$	260 for 5 seconds	

## Electrical Optical Characteristics at Ta=25

Parameter	Symbol	Min	Typ	Max	Uni	Test Condition
Radiant Intensity	$I_e$	6.0	12.0	-----	Mw/sr	$I_F=20mA$
Viewing Angle	$2_{1/2}$	----	30	-----	Deg	
	$2_{1/10}$	----	60	-----		
Peak Emission Wavelength	$\lambda_p$	830	845	855	nm	$I_F=50mA$
Spectral Line Half-Width		----	40	----	nm	$I_F=50mA$
Forward Voltage	$V_F$	1.40	1.55	1.65	V	$I_F=50mA$
Reverse Current	$I_R$	----	----	10	$\mu A$	$V_R=5V$



## Typical Electro-Optical Characteristics Curve

Forward current Vs.  
Forward voltage

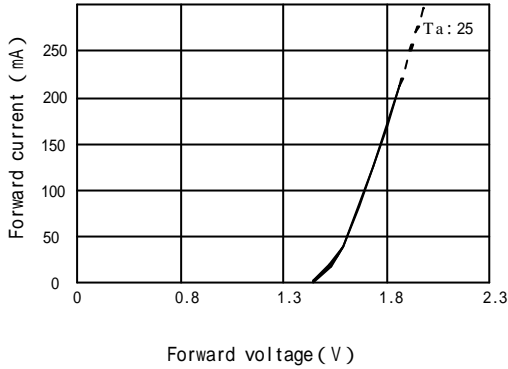

Relative Radiant power  
vs. Forward Current

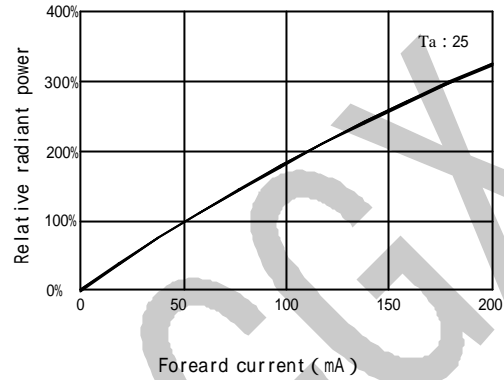

Relative Radiant power  
vs. Ambient Temperature

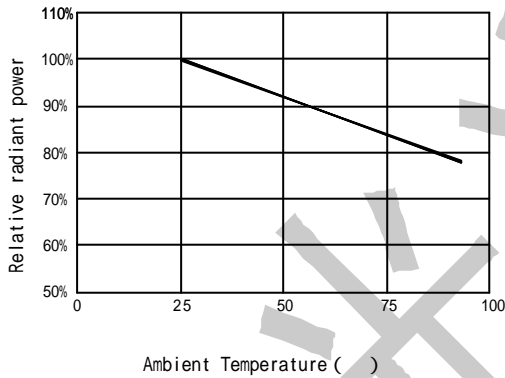

Forward Current vs.  
Ambient Temperature

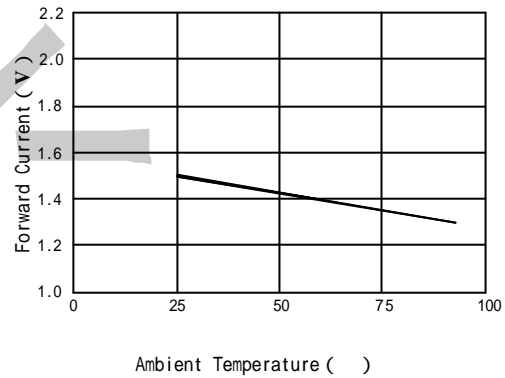

Spectral Distribution

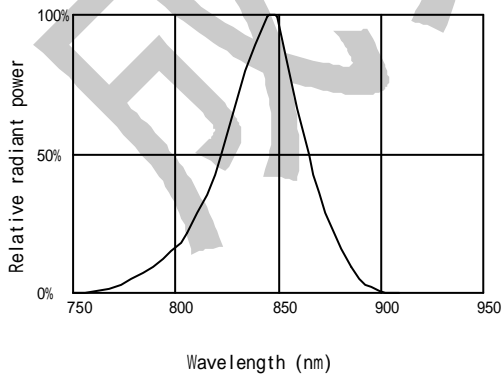

Relative Radiant Intensity  
vs. Angular Displacement

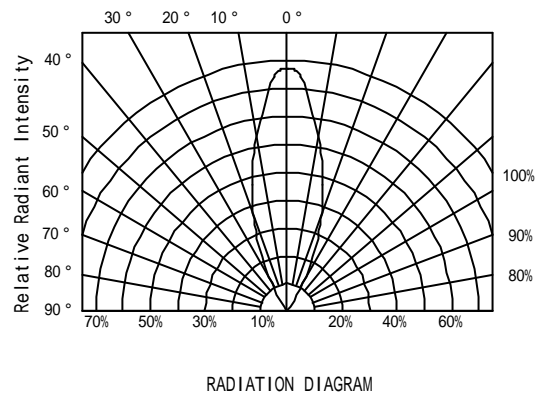



## Reliability test items and test conditions

The reliability of products shall be satisfied with items listed below.

Confidence level : 90%

LTPD (group of permitted defect rate): 10%

No.	Item	Test Conditions	Test Hours/ Cycles	Sample Sizes	Ac/Re	Reference Standard
1	REFLOW Soldering	Temp. : 260 ±5	5secs	22PCS	0/1	JEITA ED-4701 300 302
2	Temperature Cycle	H : +100 15min ~ 5 min L : -40 15min	100Cycles	22PCS	0/1	JEITA ED-4701 100 305
3	Thermal Shock	H : +100 5min ~ 10 sec L : -10 5min	100Cycles	22PCS	0/1	MIL-STD-202G
4	High Temperature Storage	Temp. : 100	1000Hrs	22PCS	0/1	JEITA ED-4701 200 201
5	Low Temperature Storage	Temp. : -40	1000Hrs	22PCS	0/1	JEITA ED-4701 200 202
6	DC Operating Life	IF = 50 mA	1000Hrs	22PCS	0/1	Tested with CGX standard
7	High Temperature/ High Humidity	85 -0.0634 Tc (Humy Tj 44.26 -0.02634 Tc 3-IP86BQD - TD /F1 10.5 Tf -0.285 Tc /RH85%				